

FRONT VIEW

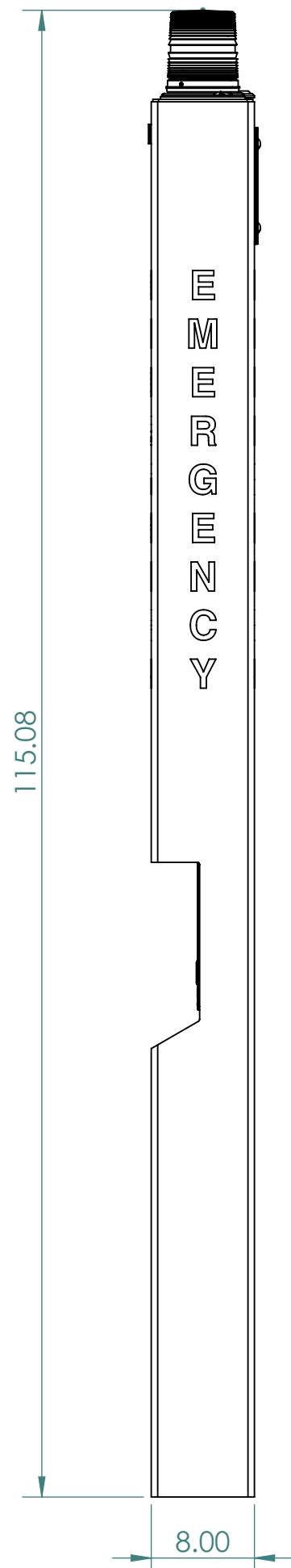

SIDE VIEW

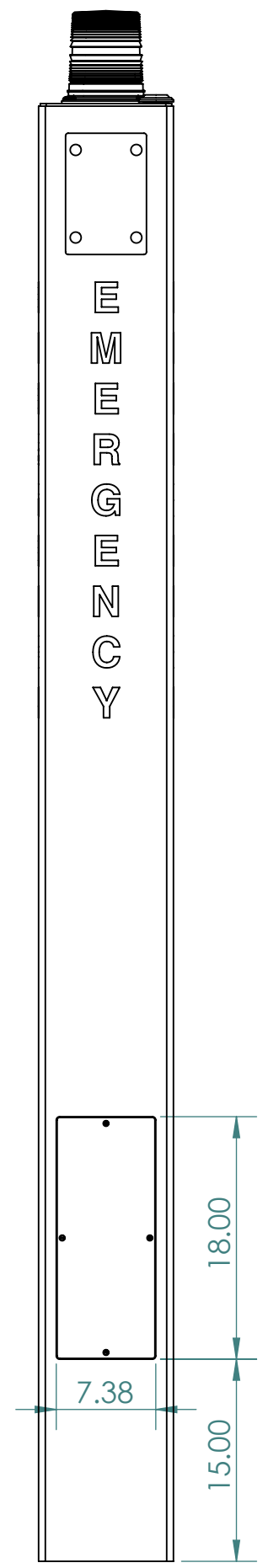

REAR VIEW

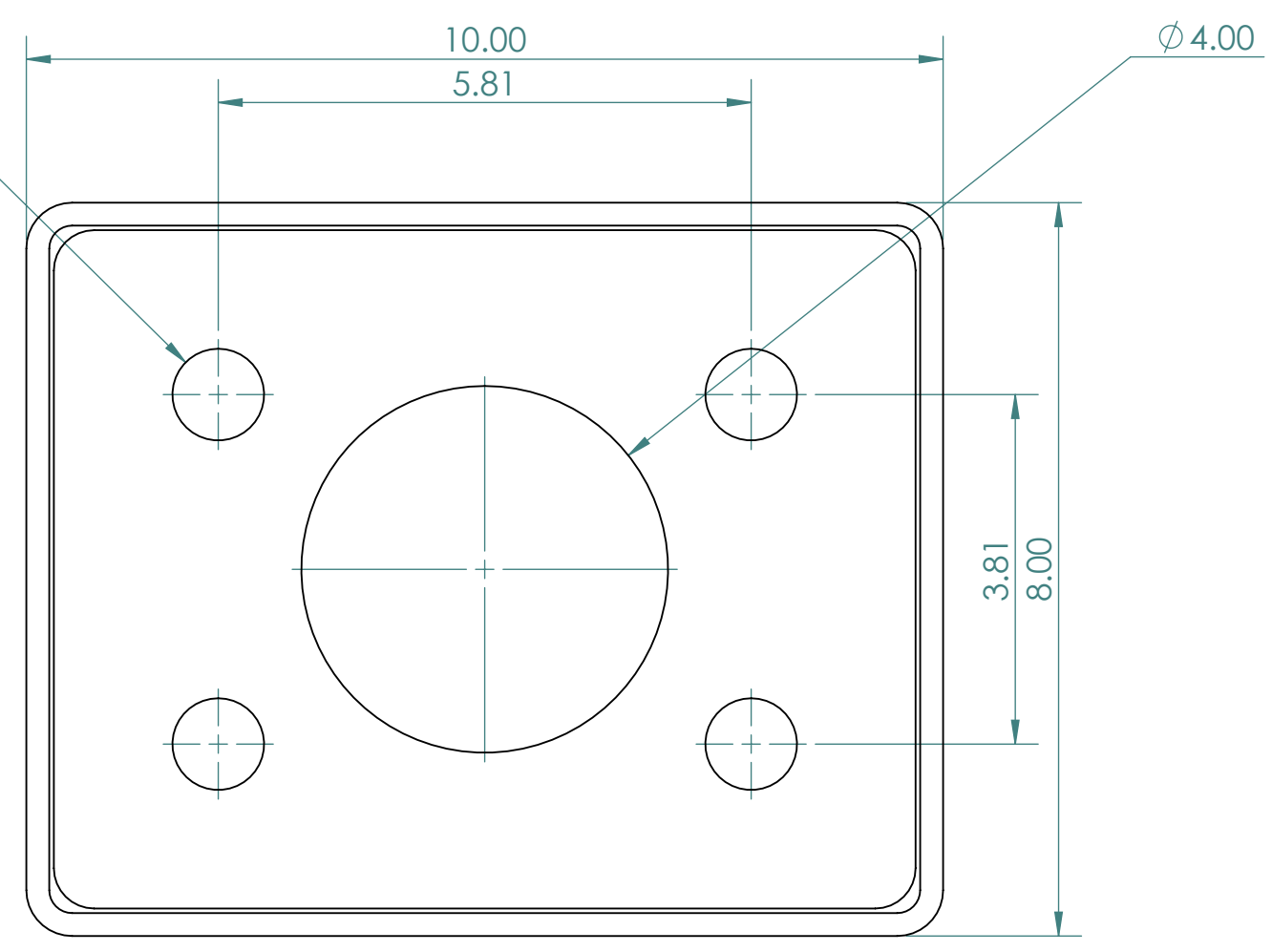

FOOT PRINT

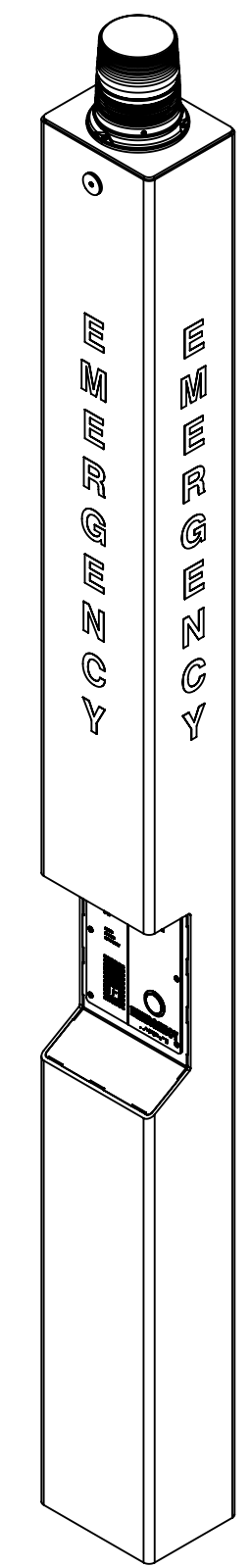

ISOMETRIC VIEW

ANTENNA PLUG HOLE

CALL STATION MODEL: VOIP-600E [SHOWN FOR ILLUSTRATION ONLY]

FINISH
 PROPRIETARY AND CONFIDENTIAL
 THE INFORMATION CONTAINED IN THIS DRAWING IS THE SOLE PROPERTY OF TALK-A-PHONE, LLC. ANY REPRODUCTION IN PART OR AS A WHOLE WITHOUT THE WRITTEN PERMISSION OF TALK-A-PHONE, LLC IS PROHIBITED.

1.0	MARKETING RELEASE	06/18/2020	J MAHETALIA
REV.	DESCRIPTION	DATE	APPROVED
REVISIONS			
	NAME	DATE	
DRAWN	J MAHETALIA	06/18/2020	
CHECKED	K PATEL	06/18/2020	
ENG APPR.			
MFG APPR.			
Q.A.			
COMMENTS:			
TALKAPHONE TALK-A-PHONE, LLC 7530 N. NATCHEZ AVE. NILES, IL 60714 WWW.TALKAPHONE.COM		DWG. NO.	
SIZE	PART NO.	ETP-MT-PCS	REV
C	DWG. TITLE: ETP-MT SERIES		1.0
SCALE: 1:12		WEIGHT:	SHEET 1 OF 2

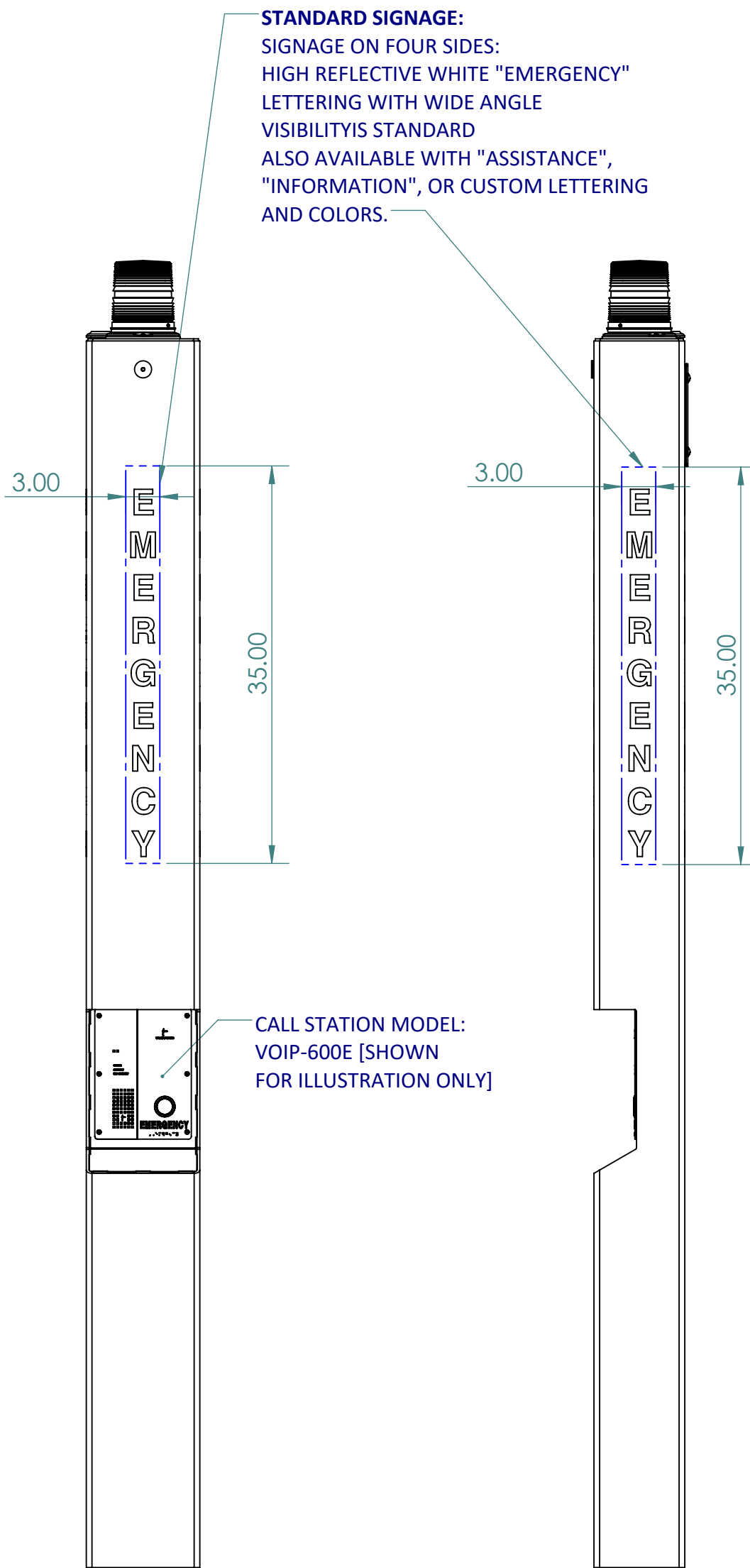

FRONT VIEW

SIDE VIEW

STANDARD SIGNAGE:
SIGNAGE ON FOUR SIDES:
HIGH REFLECTIVE WHITE "EMERGENCY"
LETTERING WITH WIDE ANGLE
VISIBILITY IS STANDARD
ALSO AVAILABLE WITH "ASSISTANCE",
"INFORMATION", OR CUSTOM LETTERING
AND COLORS.

CALL STATION MODEL:
VOIP-600E [SHOWN
FOR ILLUSTRATION ONLY]

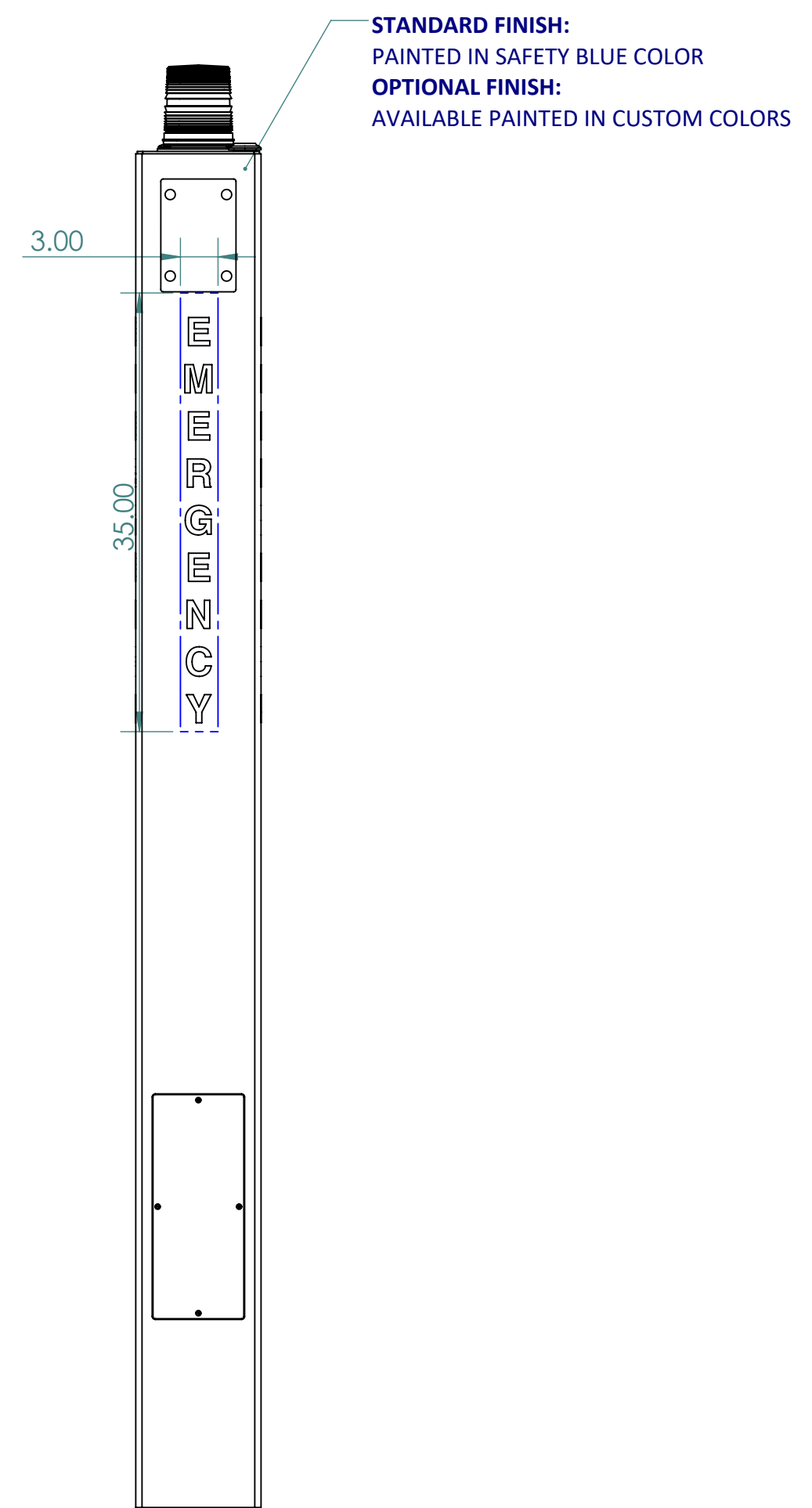

REAR VIEW

STANDARD FINISH:
PAINTED IN SAFETY BLUE COLOR
OPTIONAL FINISH:
AVAILABLE PAINTED IN CUSTOM COLORS

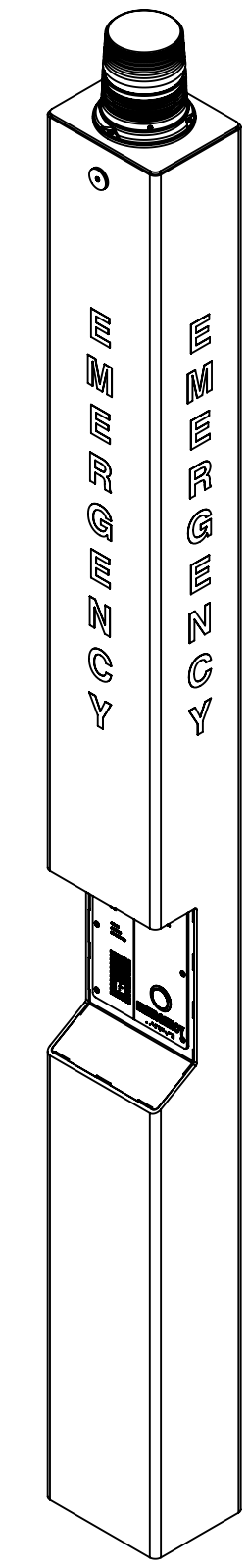

ISOMETRIC VIEW

FINISH

PROPRIETARY AND CONFIDENTIAL
THE INFORMATION CONTAINED IN THIS
DRAWING IS THE SOLE PROPERTY OF
TALK-A-PHONE, LLC. ANY
REPRODUCTION IN PART OR AS A WHOLE
WITHOUT THE WRITTEN PERMISSION OF
TALK-A-PHONE, LLC IS PROHIBITED.

	NAME	DATE
DRAWN	J MAHETALIA	06/18/2020
CHECKED	K PATEL	06/18/2020
ENG APPR.		
MFG APPR.		
Q.A.		

TALKAPHONE
TALK-A-PHONE, LLC
7530 N. NATCHEZ AVE. NILES, IL 60714
WWW.TALKAPHONE.COM

DWG. NO.

SIZE	PART NO.	ETP-MT-PCS	REV
C	DWG. TITLE:	ETP-MT SERIES	1.0
SCALE: 1:12	WEIGHT:	SHEET 2 OF 2	